

LED Parking Garage Canopy Series

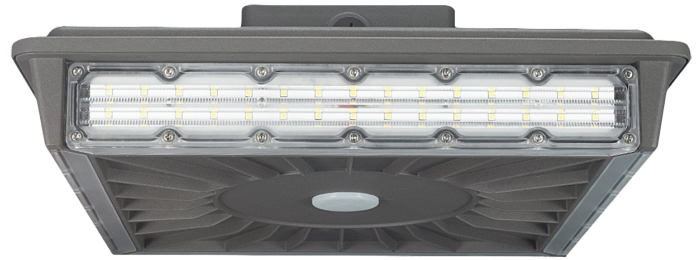

Wattages: 45W, 70W

LED Parking Garage Canopy Series can be widely used in indoor or outdoor lighting (wet location). Ideal for museums, art galleries, parking garage, buildings, the lawn, industrial areas, residential areas, sidewalks, schools, and many more applications.



Side View



FEATURES

- Lumileds LED, high luminous efficiency and long working life.
- High efficiency LED Driver, the wide range input voltage AC120-277V.
- Excellent optics design, greatly improve the light utilization and evenness.
- Motion sensor control available (Optional) .
- 1-10V Dimming.



Die-cast aluminum cooling design, high quality and better cooling for LED $T_j < 85^{\circ}\text{C}$.

White Finish

SPECIFICATION		
WATTAGE	45W	70W
LUMEN	5625 lm	8750 lm
EFFICACY	125 lm/W	125 lm/W
CCT	4000K, 5000K	
CRI	70	
UPLIGHT	15%	
INPUT VOLTAGE	120-277V	
POWER FACTOR	0.95	
DRIVER EFFICACY	90%	
DIMMING	1-10V Dimming	
LIGHT ANGLE	270°	
LIFE SPAN	75,000 hrs	
WORKING TEMPERATURE	-22°F ~ 113°F	
STORAGE TEMPERATURE	-40°F ~ 176°F	
OUTDOOR RATING	Wet location/IP66	
CABLE	Input Connect, (11.8 inch)	
WARRANTY	5 year limited	



Wattages: 45W, 70W

DIMENSION

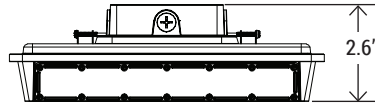
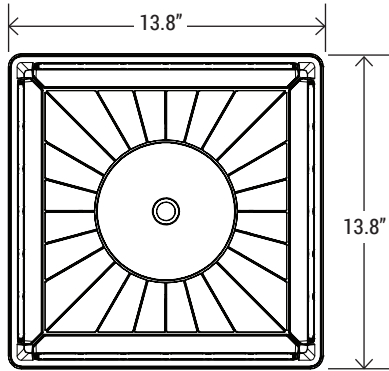

WATTAGE	45W / 70W
NT. WEIGHT	10.56 lbs
BOX DIM.	14.76" x 14.76" x 5.31"

PHOTOCELL (SOLD SEPARATELY)



BRI823-B-D AC120-277V
Motion sensor BRI823 for PGC



BRI810 AC120-277V // BRI810-C-F
LED Area Light Motion Sensor



BRI810-B-M8
Mounts in an outdoor lighting fixture and provides multi-level control based on motion and/or daylight contribution



RC-100
Remote Controller

EMERGENCY BACK-UP (SOLD SEPARATELY)



SB-EMS8W27-XX
8W Emergency Backup Battery
LED Driver

SB-EMS15W27-XX
15W Emergency Backup Battery
LED Driver

SB-EMS20W27-XX
20W Emergency Backup Battery
LED Driver

ORDERING INFORMATION

EXAMPLE:

SB-PGC45W27-50K-D-M / SB-PGC45W27-50K-D-M

SB	PGC	45W	27	50K	D	M
COMPANY	PRODUCT	WATTAGE	VOLTAGE	CCT	FINISH	CONTROL
SB LED INC	PGC Parking Garage Canopy	45W - (45W) 07W - (70W)	27 (AC120-277V)	40K - (4000K) 50K - (5000K)	D - (Dark Bronze) W - (White)	M - (Motion sensor)



Wattages: 45W, 70W

PHOTOMETRICS

For complete IES files, please visit our website.

SB-PGC45W27-50K LUMINOUS

INTENSITY DISTRIBUTION DIAGRAM

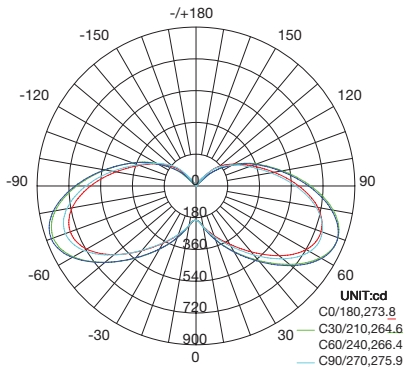

AVERAGE BEAM ANGLE(50%):270.2 DEG

C0 PLANE ISOLUX DIAGRAM (UNIT:lx)

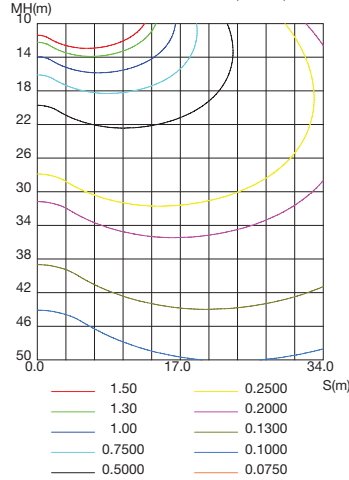

ISOLUX DIAGRAM

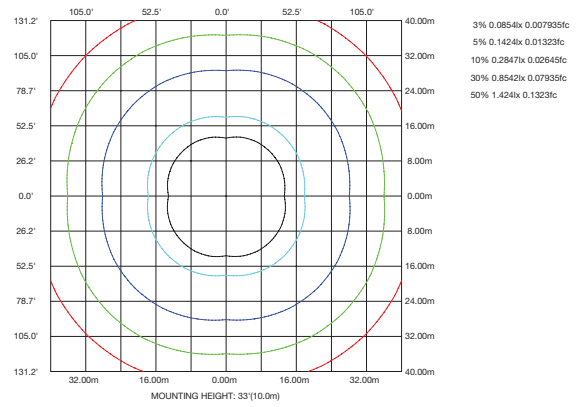

SB-PGC07W27-50K LUMINOUS

INTENSITY DISTRIBUTION DIAGRAM

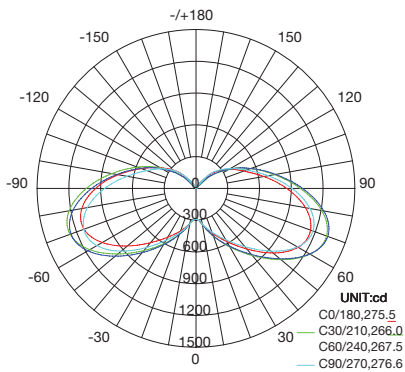

AVERAGE BEAM ANGLE(50%):271.4 DEG

C0 PLANE ISOLUX DIAGRAM (UNIT:lx)

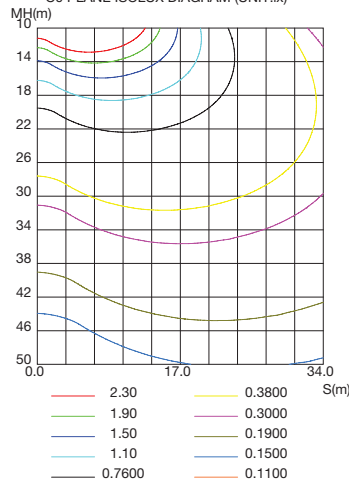

ISOLUX DIAGRAM

