

SELECTABLE LED SHOEBOX LIGHT

Wattages: 60W,90W,120W,150W;120W,180W,240W,300W



WATT/CCT
SELECTABLE

The Selectable LED Shoebox Lighting Series can be widely used for Outdoor Excellent for Parking Lots, Pedestrian Walkways, Roadways, Tennis Courts, Basketball Courts, Stadiums, Arenas, Schools, Residential Areas and many other applications.



Features:

- Optical design, greatly improved the light utilization and evenness
- High efficiency LED Driver, voltage AC120-277V/277-480V
- Cast Aluminum design, better cooling, light quality, LED Tj <85°C
- Photocell Control & Motion Sensor (Optional)
- 1-10V dimming (10%-100%) standard
- CCT:4000-5000K
- 5 years manufacturer warranty
- Compatible with most Lutron and Leviton dimmers

Packaging information:

❖ **SB691215W27-45K**
SB691215W48-45K
555MMX330MMX135MM(1Pcs/CTN)
(21.85" X12.99" X5.31")

❖ **SB12182430W27-45K**
SB12182430W48-45K
585MMX370MMX140MM(1Pcs/CTN)
(23.03" X14.57" X5.51")

SPECIFICATION				
TYPE	SB691215W27-45K	SB691215W48-45K	SB12182430W27-45K	SB12182430W48-45K
WATTAGE	60W/90W/120W/150W	60W/90W/120W/150W	120W/180W/240W/300W	120W/180W/240W/300W
LUMEN	21021 lm(150W&4000K)	20929 lm(150W&4000K)	44714 lm(300W&4000K)	44031 lm(300W&4000K)
EFFICACY	> 145 lm/W			
CCT	4000K,5000K			
CRI	> 70			
INPUT VOLTAGE	AC120-277V/277-480V			
LIGHTING ANGLE	118°			
FACTORY SETTINGS	150W & 4000K		300W & 4000K	
LED TYPE	SMD2835			
PF	> 0.98			
DRIVER EFFICIENCY	> 90%			
PROTECTION LEVEL	Wet location			
LIFE TIME	> 75000 hours			
WARRANTY	5 year limited			

SELECTABLE LED SHOEBOX LIGHT

Wattages: 60W,90W,120W,150W;120W,180W,240W,300W

DIMENSION:

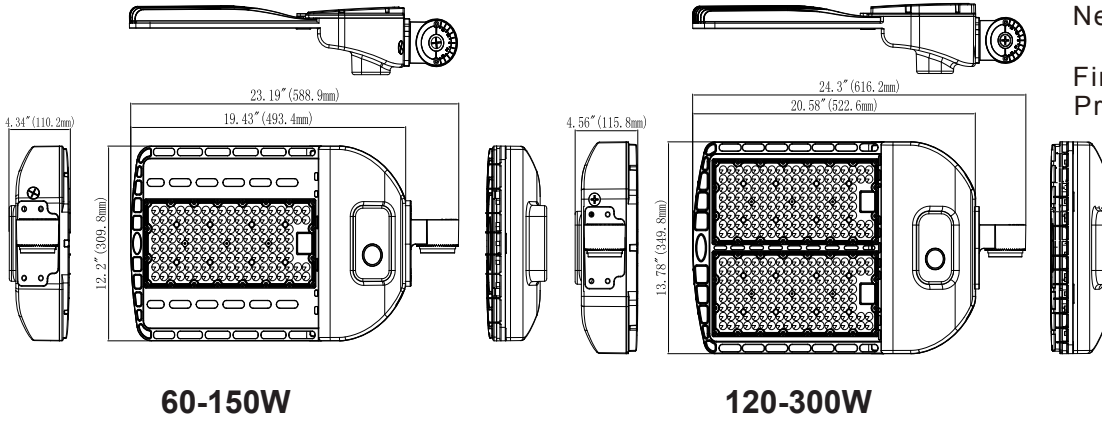

SPECIFICATIONS:

Shell materials: Aluminum & PC.

Net weight : 11.16 lbs (150W)

16.01 lbs (300W)

Finish: Dark Bronze(Standard)

Product Size:

150W:588.9X309.8X110.2(mm)

23.19"X12.2"X4.34"

300W:612.2X349.8X115.8(mm)

24.3"X13.78"X5.56"

MOUNTING OPTIONS:(SOLD SEPARATELY)



NEWSBARM2-D

Arm Mount Square and Round poles) Standard versatile mounting arm is simple to install and can be used with existing poles for retro t installations.



WNEWSBSF2-D

Slipfitter Mount An optional cast aluminum mast arm adapter secures fixture head to nominal 2"(2-3/8"O.D. pipe size) horizontal steel tenon arm.



SBT-D

Wall Mount Wall Mount is easy to install for direct wall mounting with 1/2' conduit wiring mounting.

PHOTOMETRICS:

Type 2:

Type 2 optics produce a symmetrical pattern that evenly shines light on both sides of the lamp. In a back-to-back configuration, it creates a rectangular

Type 3:

Type 3 optics produce an asymmetrical pattern that directs the majority of the light forward and equally on both sides of the luminaire. In a back-to-back configuration, it creates a rectangular pattern

Type 4:

Type 4 is suitable for applications where light is primarily required forward with minimal backlight. Typical installations include perimeter poles.

Type 5:

Type 5 optics produce a symmetrical square distribution pattern that distributes light equally on all sides of the luminaire. Type 5 luminaires is universal for most area lighting applications

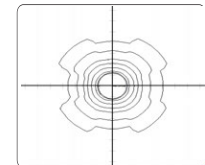
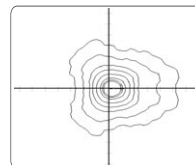
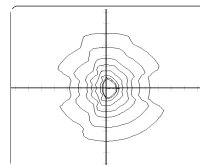
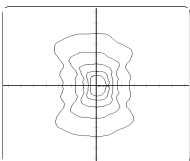

SELECTABLE LED SHOEBOX LIGHT

Wattages: 60W,90W,120W,150W;120W,180W,240W,300W







CONTROL MODULE:



WATT/CCT
FIELD-ADJUSTABLE

Simply select desired CCT and Wattage before installation

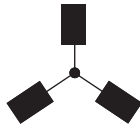
EPA OF AREA LIGHT

Item							
	1	2 @90°	2 @120°	2@180°	3 @90°	3 @120°	4 @90°
60-120W	0.641	1.282	1.481	1.382	1.923	1.743	2.564
150W	0.642	1.284	1.461	1.393	1.926	1.762	2.568
180-240W	0.644	1.288	1.466	1.376	1.966	1.768	2.576
300W	0.677	1.354	1.495	1.371	2.031	1.965	2.708

PERFORMANCE



SPECIFICATION

TYPE	SB691215W27-45K/SB691215W48-45K								SB12182430W27-45K/SB12182430W48-45K							
	60W (TYPEIII)		90W (TYPEIII)		120W (TYPEIII)		150W (TYPEIII)		120W (TYPEIII)		180W (TYPEIII)		240W (TYPEIII)		300W (TYPEIII)	
POWER	60W (TYPEIII)	90W (TYPEIII)	120W (TYPEIII)	150W (TYPEIII)	120W (TYPEIII)	180W (TYPEIII)	240W (TYPEIII)	300W (TYPEIII)	120W (TYPEIII)	180W (TYPEIII)	240W (TYPEIII)	300W (TYPEIII)	120W (TYPEIII)	180W (TYPEIII)	240W (TYPEIII)	300W (TYPEIII)
CCT	4000K	5000K	4000K	5000K	4000K	5000K	4000K	5000K	4000K	5000K	4000K	5000K	4000K	5000K	4000K	5000K
LUMENS	9000	8700	13050	12790	16680	16200	21021	20712	18720	17880	27180	26460	35280	34320	44714	43891
EFFICACY	> 150	> 145	> 145	> 140	> 140	> 135	> 140	> 135	> 155	> 150	> 150	> 145	> 145	> 140	> 145	> 140

SELECTABLE LED SHOEBOX LIGHT

Wattages: 60W,90W,120W,150W;120W,180W,240W,300W

PHOTOCELL & MOTION SENSORS (SOLD SEPARATELY)

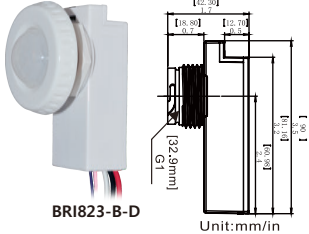
	<p>Photocell No. LC-10DT-74-X6 Finish: Blue USE: Used for indoor or outdoor LED lamps, working with light sensing principle, the LC-10DT-74-X6 sensor (LC-10DT-74-X6 for 120-277V) is used for Light sensor.</p>		<p>SPECIFICATIONS AND CHARACTERISTICS:</p> <ul style="list-style-type: none"> • UL Listed. Reference No.: E178670 Volts & Cover Color • Blue standard for 120-277VAC • Turn-ON Light Level: 10-16 Lux • Turn ON/OFF Ratio: 1:1.5 to 3 • Time Delay: 2-10 sec • Operating Temperature: -40°C to +70°C • Relay: 15A • Energy Consumption: Less than 1Watt (120V<0.5W) • Electrical Life: >5000 cycles • Sensor Type: Silicon Photocell • Housing: UV stabilized PC • Failure Mode: Fail ON (standard), Fail OFF (for your option)
	<p>Motion Sensor No. BRI823-B-D Finish: White USE: The BRI823-B-D mounts in an outdoor lighting fixture and provides multi-level control based on motion. The sensor also includes a photocell to measure the ambient light level. It controls 0-10 VDC LED drivers, is rated for wet and cold locations. All control parameters are adjustable via a wireless configuration tool capable of storing and transmitting sensor profiles.</p>	 <p>BRI823-B-D Unit:mm/in</p>	<p>Motion Sensor No. BRI823-B-D Finish: White The BRI823-B-D mounts in an outdoor lighting fixture and provides multi-level control based on motion and/or daylight contribution. It controls 0-10 VDC LED drivers or dimming ballasts, and is rated for wet and cold locations.</p>

ORDERING INFORMATION:

EXAMPLE:

SB691215W27-45K-Z[D,W,B,S]-TN-U[S,A,T]-Y[Blank,P]-E[Blank,M]

SB	691215	27	45	Z	TN	U	Y	E
PRODUCT	POWER	VOLTAGE	CCT	FINISH	LIGHT ANGLE	MOUNLIGHT	CONTROL	CONTROL
SB LED SHOEBOX	691215 (60W/90W/ 120W/150W) 12182430 (120W/180W/ 240W/300W)	27 AC120-277V 48 AC277-480V	45 4000K/5000K	D (Dark Bronze) W (White) B (Black) S (Silvery)	T2 (Type II) T3 (Type III) T4 (Type IV) T5 (Type V)	S (Slip fitter) T (Trunnion) A (Arm)	P Photocell	M Motion Sensor

SELECTABLE LED SHOEBOX LIGHT

Wattages: 60W,90W,120W,150W;120W,180W,240W,300W

PHOTOMETRICS:

For complete IES files, please visit our website.

SB691215W27-45K (150W,4000K,TypeIII)

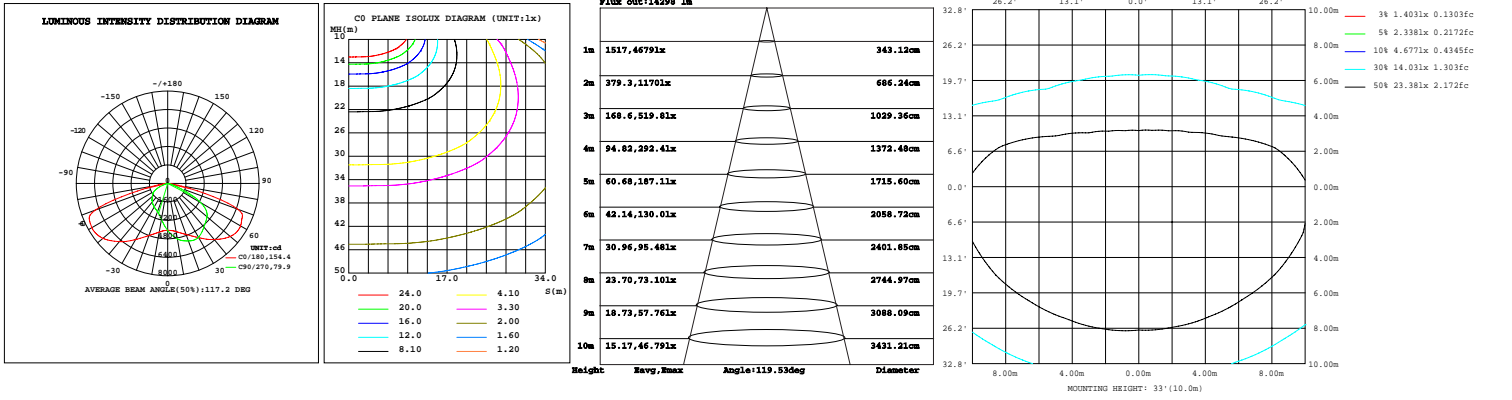

SB12182430W27-45K (300W,4000K,TypeIII)

