

Selectable Edge-Lit Light Panel

User Manual

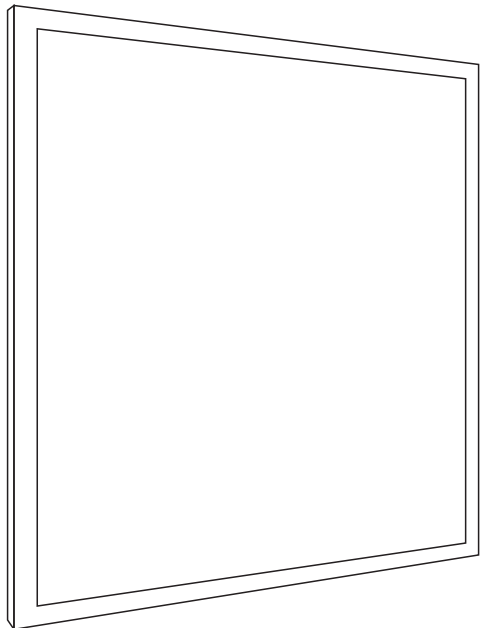

All the pictures are just for reference and we have the final explanation rights

Included Parts

LED Panel Light x1
Instruction manual x1

Safety Information

CAUTION! Risk Of Electric Shock

Turn off all power prior to installation by switching off circuit breaker or removing fuse at fuse box.

- This product should be installed by a fully certified electrician in accordance with relevant federal, state and local building and electrical codes

Common Failures & Solutions

Common Failures	Solutions
Light is out	Ensure the lamp is well connected.
	Ensure the switch is turned on.
Flashing	Ensure the Voltage is stable.
	Ensure the dimmer is compatible.

Size

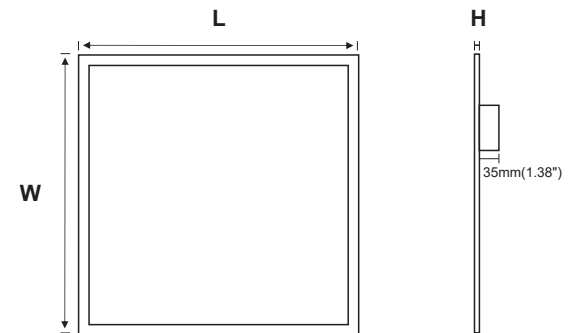

SIZE	L X W X H (mm)	L X W X H (Inch)
American Size		
2FT X 2 FT	603 X 603 X 9 mm	23.74 X 23.74 X 0.36"
1FT X 4 FT	301 X 1213 X 9 mm	11.85 X 47.76 X 0.36"
2FT X 4 FT	603 X 1213 X 10 mm	23.74 X 47.76 X 0.4"

Wiring

● 0-10V dimming

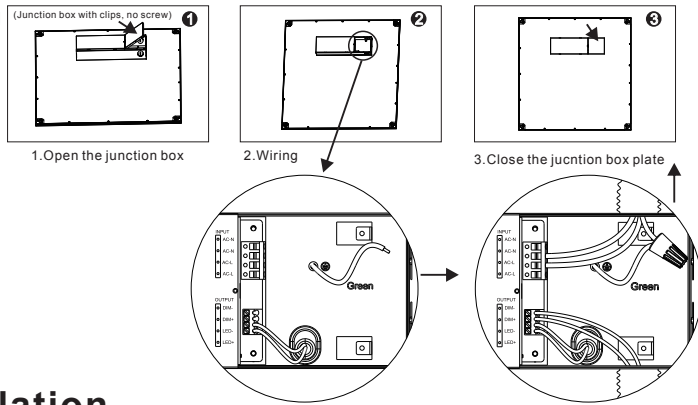

Installation

Recession

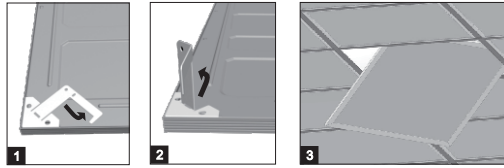

Suspension

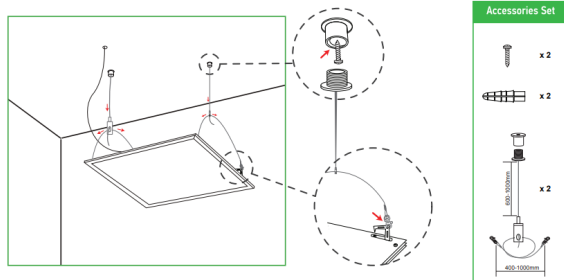

Notes

1. Indoor lighting only.
2. Before installation, ensure the LED panel is not damaged.
3. Don't stare at the LED luminous surface for long time.
4. Keep away from children, and ensure working electrical apparatus inaccessible to them.
5. No packages accessible to children, because they might be choked for playing, or eating the small accessories.
6. No covering, be away from fire or high-temperature substance.
7. Manufacturer reserves the right to offer no replacement or warranty to the led panels disassembled or repaired by users themselves.
8. Cut off power before cleaning the panels with dry cloth, use no chemical or corrosive substance.
9. Cut off power before installation.
10. This product must be installed flat and level.

Surfaced mounted

● Surfaced Mounted Frame

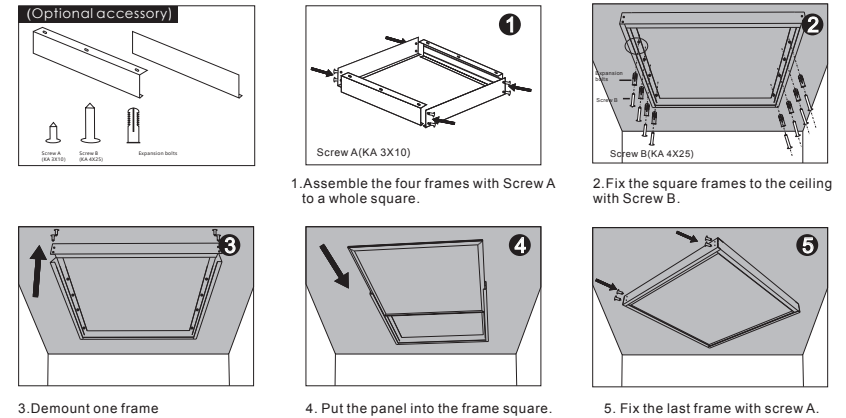

Recessed Frame

● Recessed Frame

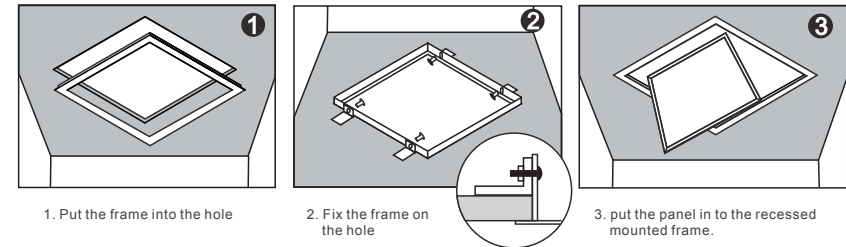

FCC Notes

This device complies with Part 15 of the FCC Rules. Operation is subject to the following two conditions: (1) this device may not cause harmful interference, and (2) this device must accept any interference received, including interference that may cause undesired operation.

Changes or modifications to this unit not expressly approved by the party responsible for compliance could void the user's authority to operate the equipment.

NOTE: This equipment has been tested and found to comply with the limits for a Class B digital device, pursuant to Part 15 of the FCC Rules. These limits are designed to provide reasonable protection against harmful interference in a residential installation. This equipment generates, uses and can radiate radio frequency energy and, if not installed and used in accordance with the instructions, may cause harmful interference to radio communications. However, there is no guarantee that interference will not occur in a particular installation. If this equipment does cause harmful interference to radio or television reception, which can be determined by turning the equipment off and on, the user is encouraged to try to correct the interference by one or more of the following measures:

- Reorient or relocate the receiving antenna.
- Increase the separation between the equipment and receiver.
- Connect the equipment into an outlet on a circuit different from that to which the receiver is connected.
- Consult the dealer or an experienced radio/ TV technician for help.