

Size: 4" (4" x 4"), 5" (5" x 5")

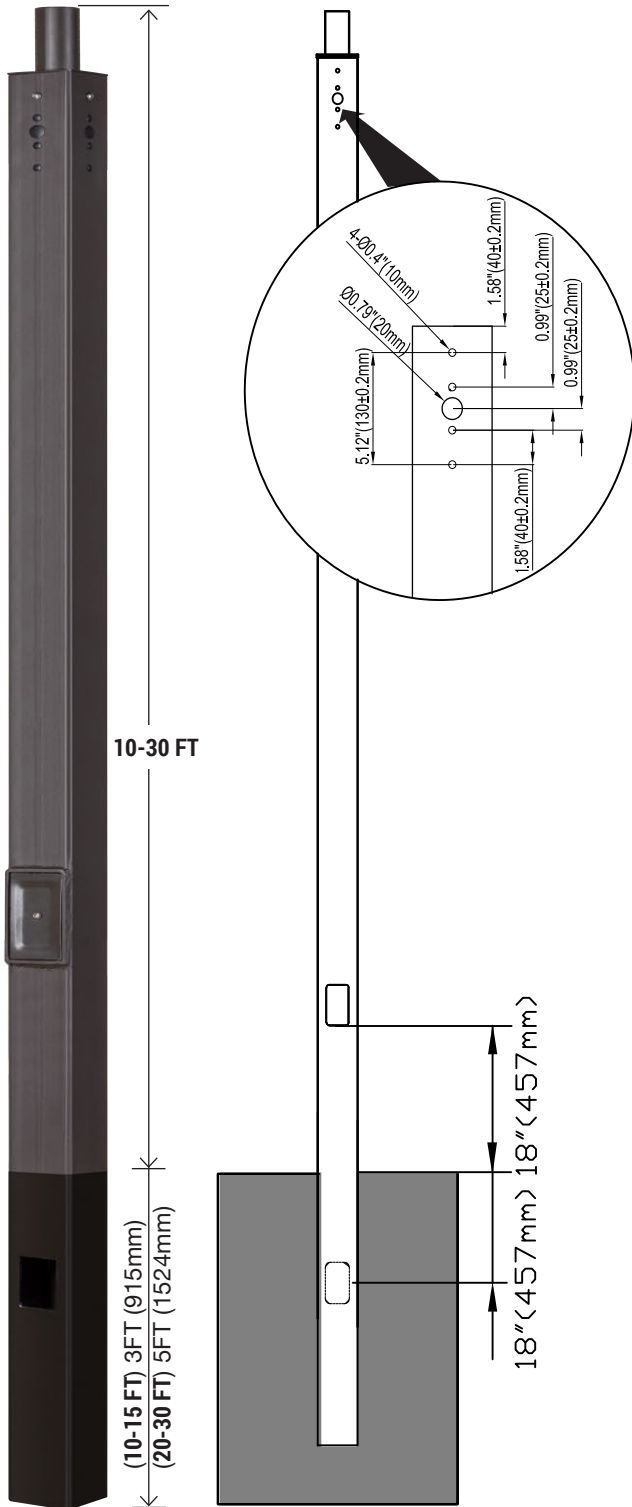

The SB LED INC Series Direct Burial Straight Square Steel poles are built from high strength steel tube and are available side drilled for arm mounted area lighting luminaires or with tenon mounts for flood and post top luminaires. Typical area lighting applications include retail centers, industrial parks, schools and universities, public transit and airports, office buildings and medical facilities. Mounting heights of 10 to 30 feet can be used based on selected luminaire application.

(ACCESSORIES NEED TO PURCHASED SEPARATELY)

FEATURES

FINISH:

Textured architectural bronze powder-coat finish, baked to ensure maximum paint adhesion, hardness and durability.

ANCHOR BOLTS:

Anchor bolts are not included, sized based on pole data charts for the selected pole size.

POLE LENGTH:

Poles are available in standard lengths as shown in the order matrix. Poles can be custom cut to order. Consult factory.

SURFACE TREATMENT:

Hot-dip galvanizing.

Note: When using Arm or Slip-Fitter Mounts, additional installation parts may be required to ensure proper installation. (example: with Slip-fitter a bullhorn will be the option) *see: additional installation parts for more options*

TOP MOUNT: Installing ARM (optional) will need to take-off the Tenon standard package and put rain cover on top.

SPECIFICATIONS: Conforms to ASTM-A 500 Grade B: Minimum Yield Strength of 46,000 PSI.

SPECIFICATION	10FT	15FT	20FT	25FT	30FT
SB-DBS10FT4-11G-D-T					
SB-DBS15FT4-11G-D-T					
SB-DBS20FT4-11G-D-T	L = 3.0 (m) (GROUND HEIGHT)	L = 4.6 (m) (GROUND HEIGHT)	L = 6.1 (m) (GROUND HEIGHT)	L = 7.6 (m) (GROUND HEIGHT)	L = 9.1 (m) (GROUND HEIGHT)
SB-DBS25FT4-11G-D-T					
SB-DBS30FT5-11G-D-T					

DIRECT UNDERGROUND BURIAL:

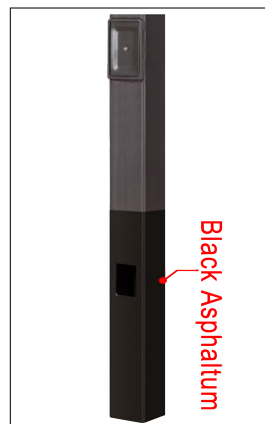

BLACK ASPHALTUM: Black Asphaltum is an economical, highly protective, acid and alkali-resistant coating designed for Direct burial Light Pole use.

This protective coating is applied on either galvanized or powder-coated products to add a supplemental layer of corrosion protection. This combination of galvanizing and/or powder coating coupled with black Asphaltum provides the best below-grade corrosion resistance in the Light Pole industry.

ADVANTAGE:

- Rust proofing properties
- Superior resistance to acids and alkali
- Outstanding adhesion and wear resistance

Direct Burial Straight Square Steel Poles

Size: 4" (4" x 4"), 5" (5" x 5")

DIMENSION (Standard Fittings)

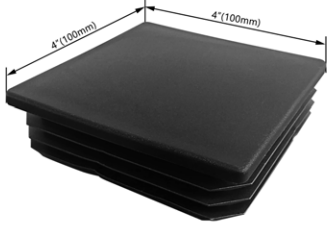

4 foot light pole to use

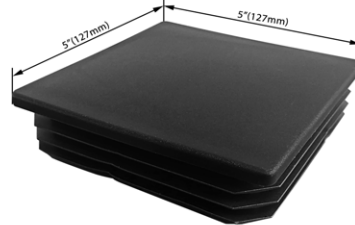

5 foot light pole to use

DIMENSION DATA

CATALOG	GROUND HEIGHT	GAUGE	SIZE	SUBSURFACE DEPTH	WEIGHT (LBS)	EPA 70	EPA 80	EPA 90	EPA 100	EPA 110	EPA 120	EPA 130	EPA 140
SB-DBS10FT4-11G-D-T	10ft	11	4"x4"	3 ft	88	25.2	23.5	20.3	19.4	17.3	15.6	12.3	9.8
SB-DBS15FT4-11G-D-T	15ft				121	15.2	13.5	11.1	9.5	7.9	6.8	5.2	3.8
SB-DBS20FT4-11G-D-T	20ft			167	10.2	9.3	7.5	6.2	4.2	3.6	2.2	1.0	
SB-DBS25FT4-11G-D-T	25ft			198	8.9	6.9	5.7	4.1	3.6	2.2	1.1	0.8	
SB-DBS30FT5-11G-D-T	30ft		5"x5"	5 ft	286	9.6	7.4	6.1	5.8	4.6	3.8	2.5	1.5

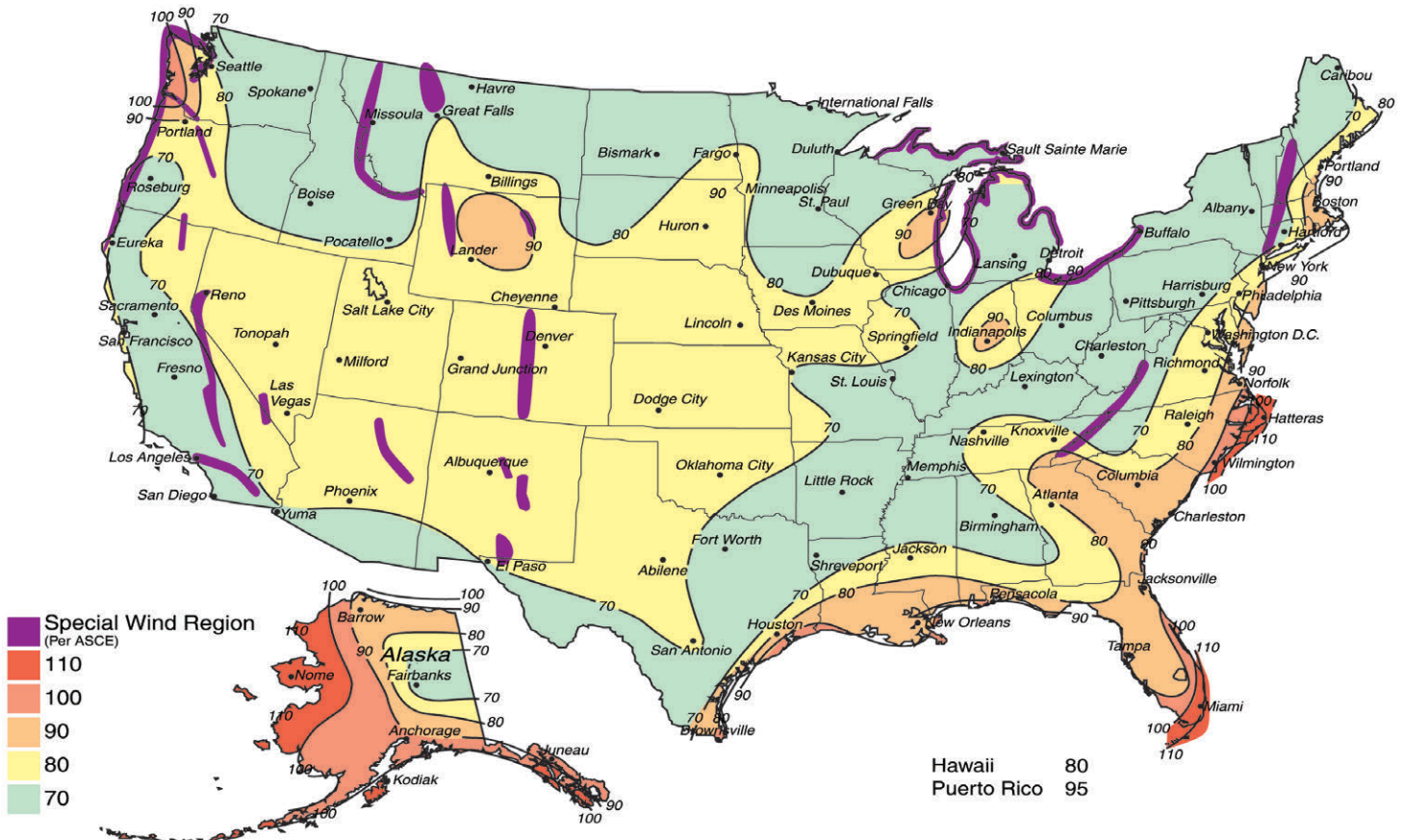

Size: 4" (4" x 4"), 5" (5" x 5")

ORDERING INFORMATION

EXAMPLE: **SB-DBS10FT4-11G-D-T**

SB	DBS	10FT	4	11G	D	T
COMPANY	PRODUCT	GROUND HEIGHT	SIZE	THICKNESS	FINISH	MOUNTING
SB LED INC	Direct Burial Straight Square Steel poles	10FT - (3.0 M) 15FT - (4.6 M) 20FT - (6.1 M) 25FT - (7.6 M) 30FT - (9.1 M)	4 - (4" x 4") 5 - (5" x 5")	11G - (11 gauge)	D - (Dark Bronze)	T - (2.5" Adapter)

FIXTURE CONFIGURATIONS

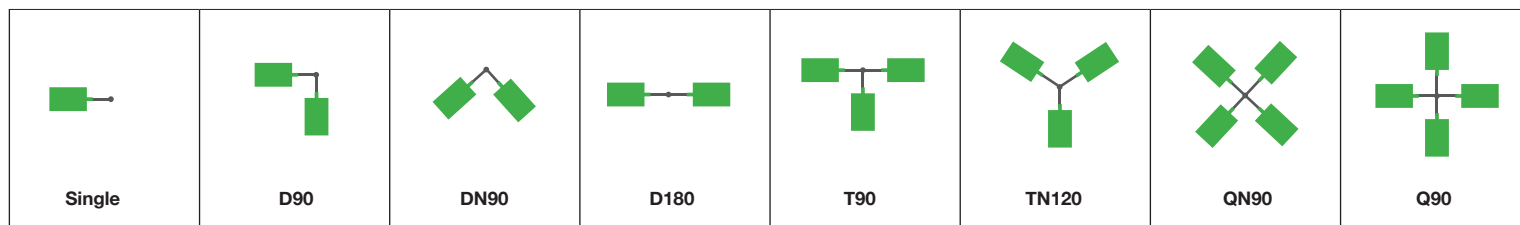

INSTALLATION

Installation Guide

Step 1. After digging the corresponding size foundation hole by pressing the table at the location of the light pole installation, put the embedded end of the light pole into the hole, and keep it perpendicular to the ground, and fix it with concrete casting.

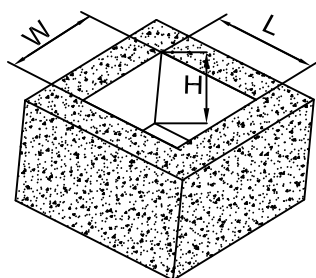
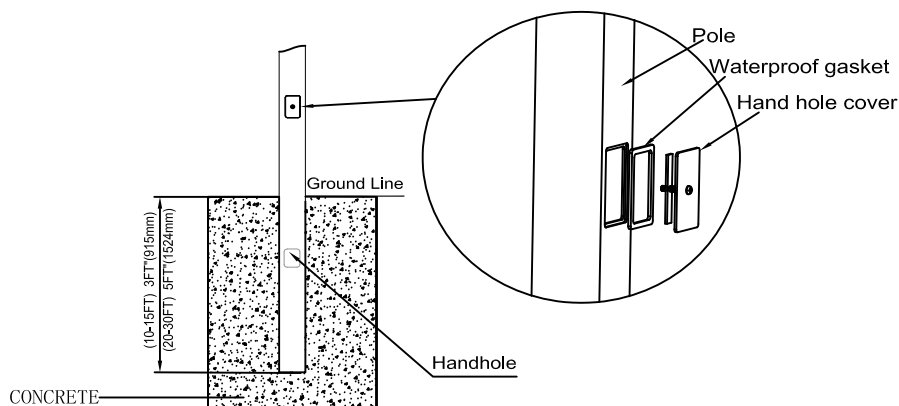





Specifications	L	W	H
10-15FT	23.62"(600mm)	23.62"(600mm)	43.3"(1100mm)
20-30FT	27.56"(700mm)	27.56"(700mm)	67"(1700mm)

Size: 4" (4" x 4"), 5" (5" x 5")

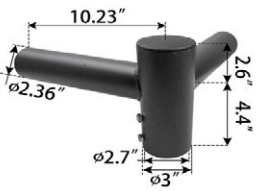
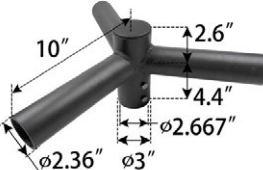
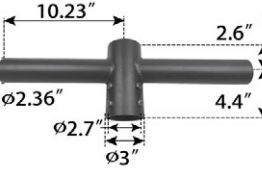
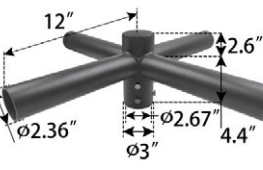
SQUARE EXTERNAL MOUNT HORIZONTAL TENON		• To mount 2/3/4 fixtures on an existing pole	
<p>45" (1143mm) 3-Ø2.36" (60mm) 20.5" (520mm) 4.72" (120mm) 1.73" (44mm) 4-M8 1.24" (31.5mm) Ø3" (76mm)</p>	<p>Low Profile Bullhorn with 3 Tenons SB-VTS4R-3T-D MAX EPA: 1.6 Finish: Dark Bronze The Bracket is designed to mount over 2-3/8" O.D. vertical tenon.</p>	<p>20.5" (520mm) Ø2.4" (60mm) 4.7" (120mm) 24.6" (624.38mm) 2.3" (76mm)</p>	<p>Low Profile Bullhorn with 2 Tenons SB-VTS4R-2T-D MAX EPA: 1.0 Finish: Dark Bronze The Bracket is designed to mount over 2-3/8" O.D. vertical tenon.</p>
<p>11.62" (295.23mm) 9.56" (242.8mm) 120° 9-Ø3.8" (96mm) 4.72" (120mm) 1.73" (44mm) 1.18" (30mm) Ø3" (76mm)</p>	<p>Triple 120° Horizontal Tenon Adapter SB-QT120-3T-D MAX EPA: 1.4 Finish: Dark Bronze The Bracket is designed to mount over 2-3/8" O.D. vertical tenon.</p>	<p>20" (508mm) 12" (305mm) 12" (305mm) 12" (305mm) 1.18" (30mm) 1.18" (30mm) 1.18" (30mm) 1.18" (30mm)</p>	<p>Quad 90° Horizontal Tenon Adapter SB-QT90-4T-D MAX EPA: 1.6 Finish: Dark Bronze The Bracket is designed to mount over 2-3/8" O.D. vertical tenon.</p>
WALL BRACKET • Attaches to any flat surface • Provides wiring access		MID-POLE TENON BRACKET	
<p>Ø2.36" 7" 5.9" 7" 7.8"</p>	<p>90° Wall Mount Bracket with 2-3/8" O.D. Tenon SB-ADP2.5-90-D MAX EPA: 0.6 Finish: Dark Bronze The 90° wall mount bracket with 2-3/8" tenon attaches flood and area fixtures to almost any surface: wall, roof, or wood pole. Provides wiring access and a built-in 2-3/8" O.D. tenon to mount a fixture with our adjustable slip-fitter. Suggested 3/8" diameter bolts for mounting.</p>	<p>3.93" 3.93" 8" 0.12" Ø2.36" 4.92" 3.75" 5.6"</p>	<p>2-3/8" OD Horizontal Tenon Mid-Pole Bracket SB-ADP2.5-D MAX EPA: 0.3 Finish: Dark Bronze 2-3/8" OD Horizontal Tenon Mid-Pole Bracket is designed to mount light fixture that is equipped with a adjustable slip-fitter onto a 2-3/8" OD horizontal tenon.</p>
<p>Ø54 Ø60 3.9" (99mm) 90° 6" (152mm) 7" (177.8mm) R2 4-Ø9 0.16" (4mm)</p>	<p>180° Wall Mount Bracket with 2-3/8" O.D. Tenon SB-ADP2.5-180L3.9-D MAX EPA: 0.5 Finish: Dark Bronze The 180° wall mount bracket with 2-3/8" tenon attaches flood and area fixtures to almost any surface: wall, roof, or wood pole. Provides wiring access and a built-in 2-3/8" O.D. tenon to mount a fixture with our adjustable slip-fitter. Suggested 3/8" diameter bolts for mounting.</p>	<p>Ø2.36(60mm) Ø2.13(54mm) 8" (203.2mm) 1125.4mm 0.49112.4mm 3176.2mm 3176.2mm 5.04(128mm) 0.16(4mm) 1125.4mm 1125.4mm 1125.4mm 1125.4mm</p>	<p>2-3/8" OD Horizontal Tenon Arc Adapter SB-ADP2.5-BAR5-D MAX EPA: 0.3 Finish: Dark Bronze For use with Round, non-tapered steel and aluminum poles. 2-3/8" OD Horizontal Tenon Mid-Pole Bracket is designed to mount light fixture that is equipped with a adjustable slip-fitter onto a 2-3/8" OD horizontal tenon.</p>
POLE BRACKET • For mounting one fixture on an existing pole			
<p>Ø2.38" 4.33" 4.0" 8.6" 3.5"</p>	<p>4" Square Pole Mount with 2-3/8" O.D. Tenon SB-VTS4-D MAX EPA: 0.3 Finish: Dark Bronze For use with square, non-tapered steel and aluminum poles. Furnished with four 5/16" hex head stainless-steel bolts. Vertical tenon measures 2-3/8" O.D. and is made of steel tubing.</p>	<p>Ø2.36" 4" 4.8" Ø3.15" Ø3.46"</p>	<p>3" Round Pole Mount with 2-3/8" O.D. Tenon SB-VT3-D MAX EPA: 0.3 Finish: Dark Bronze For use with round, non-tapered steel and aluminum poles. Furnished with four 3/8" hex head stainless-steel bolts. Vertical tenon measures 2-3/8" O.D.</p>
<p>Ø2.38" 5" 5" 4" 8.6" 4"</p>	<p>5" Square Pole Mount with 2-3/8" O.D. Tenon SB-VTS5-D MAX EPA: 0.3 Finish: Dark Bronze For use with square, non-tapered steel and aluminum poles. Furnished with four 5/16" hex head stainless-steel bolts. Vertical tenon measures 2-3/8" O.D., and is made of steel tubing.</p>	<p>Ø2.36" 4" 4.8" Ø4.2" Ø4.4"</p>	<p>4" Round Pole Mount with 2-3/8" O.D. Tenon SB-VT4-D MAX EPA: 0.3 Finish: Dark Bronze For use with round, non-tapered steel and aluminum poles. Furnished with four 3/8" hex head stainless-steel bolts. Vertical tenon measures 2-3/8" O.D.</p>
<p>Ø2.36" Ø2.13" 4.01" 7.88" 11.89" 4-M8 3.33" 1.97" Ø5.2" Ø5.51"</p>	<p>5" Round Pole Mount with 2-3/8" O.D. Tenon SB-VT5-D MAX EPA: 0.3 Finish: Dark Bronze For use with round, non-tapered steel and aluminum poles. Furnished with four 3/8" hex head stainless-steel bolts. Vertical tenon measures 2-3/8" O.D., and is made of steel tubing.</p>		

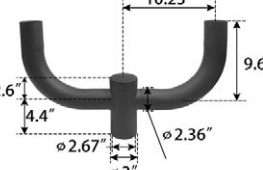
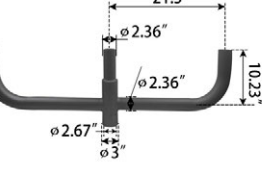
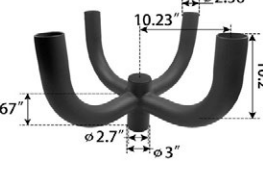
Size: 4" (4" x 4"), 5" (5" x 5")

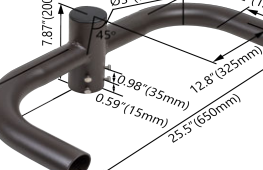
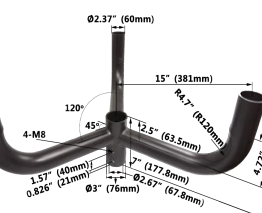
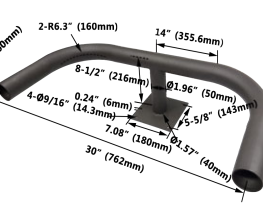
ROUND EXTERNAL MOUNT HORIZONTAL TENON To mount 2-3/4 fixtures on an existing pole			
SIGMALUX is commercial and industrial division of SNOWBALL INC. E: sales@snowball-inc.com		W: www.snowball-inc.com	
	<p>Double 90° Horizontal Tenon Adapter SB-SB2.5TW90-D MAX EPA: 0.6 Finish: Dark Bronze The Bracket is designed to mount over 2-3/8" (60mm) O.D. vertical tenon. Two fixtures can be mounted to the Round External Mount Horizontal Tenon and adjusted horizontally.</p>		<p>Triple 120° Horizontal Tenon Adapter SB-SB2.5TR120-D MAX EPA: 0.7 Finish: Dark Bronze The Bracket is designed to mount over 2-3/8" (60mm) O.D. vertical tenon. Three fixtures can be mounted to the Round External Mount Horizontal Tenon and adjusted horizontally.</p>
	<p>Double 180° Horizontal Tenon Adapter SB-SB2.5TW180-D MAX EPA: 0.4 Finish: Dark Bronze The Bracket is designed to mount over 2-3/8" (60mm) O.D. vertical tenon. Two fixtures can be mounted to the Round External Mount Horizontal Tenon and adjusted horizontally.</p>		<p>Quad 90° Horizontal Tenon Adapter SB-SB2.5QD90-D MAX EPA: 0.3 Finish: Dark Bronze The Bracket is designed to mount over 2-3/8" (60mm) O.D. vertical tenon. Four fixtures can be mounted to the Round External Mount Horizontal Tenon and adjusted horizontally.</p>
	<p>Single Spoke Bracket Tenon Adapter SB-SB2.5S90-D MAX EPA: 0.4 Finish: Dark Bronze The Bracket is designed to mount over 2-3/8" (60mm) O.D. vertical tenon. One fixture can be mounted to the Round External Mount Horizontal Tenon and adjusted horizontally.</p>		<p>Double 180° Horizontal Tenon Adapter S-RB2.5D180-D MAX EPA: 0.9 Finish: Dark Bronze The Bracket is designed to mount over 2-3/8" (60mm) O.D. vertical tenon. Two fixtures can be mounted to the Round External Mount Horizontal Tenon and adjusted horizontally.</p>
	<p>Triple 180° Horizontal Tenon Adapter SB-RB2.5TR180-D MAX EPA: 1.4 Finish: Dark Bronze The Bracket is designed to mount over 2-3/8" (60mm) O.D. vertical tenon. Three fixtures can be mounted to the Round External Mount Horizontal Tenon and adjusted horizontally.</p>		<p>Quad 90° Horizontal Tenon Adapter SB-RB2.5QD90-D MAX EPA: 1.5 Finish: Dark Bronze The Bracket is designed to mount over 2-3/8" (60mm) O.D. vertical tenon. Four fixtures can be mounted to the Round External Mount Horizontal Tenon and adjusted horizontally.</p>
	<p>90° Wall Mount Bracket with 2-3/8" O.D. Tenon SB-ADP2.5-90H-D MAX EPA: 0.7 Finish: Dark Bronze The 90° wall mount bracket with 2-3/8" tenon attaches flood and area fixtures to almost any surface: wall, roof, or wood pole. Provides wiring access and abuilt-in 2-3/8" O.D. tenon to mount a fixture with our adjustable slip-fitter. Suggested 3/8" diameter bolts for mounting. Mounting holes are spaced 3-1/4" apart.</p>		<p>Double 180° Horizontal Tenon Adapter SB-RB2.5TR180H-D MAX EPA: 1.0 Finish: Dark Bronze The Bracket is designed to mount over 2-3/8" (60mm) O.D. vertical tenon. Two fixtures can be mounted to the Round External Mount Horizontal Tenon and adjusted horizontally.</p>
	<p>Triple 120° Horizontal Tenon Adapter SB-SB2.5TR120V-D MAX EPA: 1.5 Finish: Dark Bronze The Bracket is designed to mount over 2-3/8" (60mm) O.D. vertical tenon. Three fixtures can be mounted to the Round External Mount Horizontal Tenon and adjusted horizontally.</p>		<p>Double 180° Wall Mount Bracket with 2-3/8" O.D. Tenon SB-ADP2.5-180H-D MAX EPA: 1.4 Finish: Dark Bronze The 180° wall mount bracket with 2-3/8" tenon attaches flood and area fixtures to almost any surface: wall, roof, or wood pole. Provides wiring access and abuilt-in 2-3/8" O.D. tenon to mount a fixture with our adjustable slip-fitter. Suggested 3/8" diameter bolts for mounting. Mounting holes are spaced 3-1/4" apart.</p>

