

20FT (6100mm)

1. This top should be equipped with the corresponding movable rubber plug cover to prevent rain from entering and easy to open for wiring .

2. According to the marked size on the left, measure 180 degrees on the face of the round pole 2 and add 5 hole positions respectively , the hole should be blocked with corresponding rubber plug to prevent rain from entering after opening the hole positions.

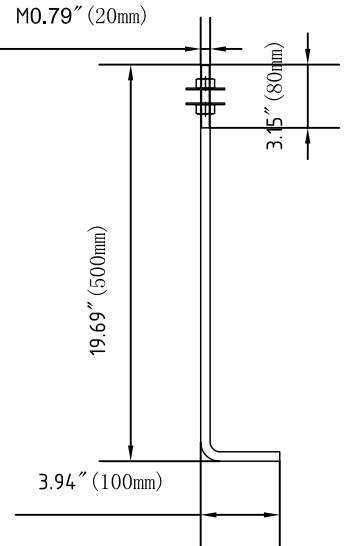

Ø4"(102mm)X0.12"(3mm)

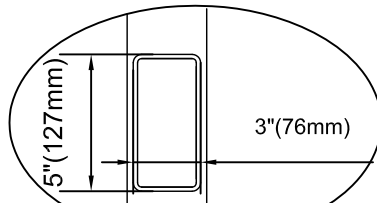
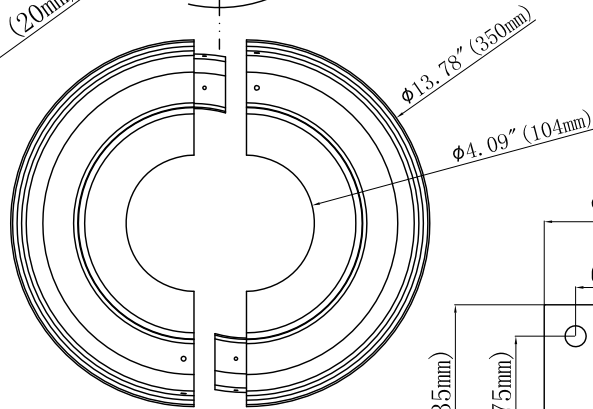
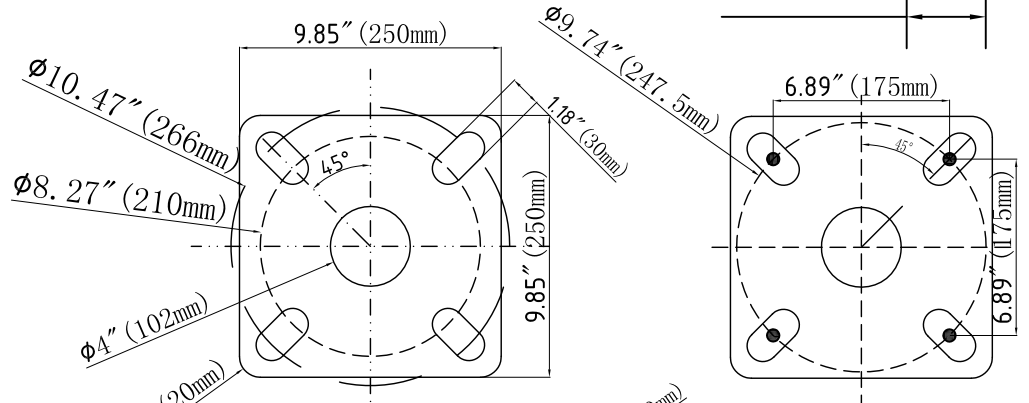

Handhole

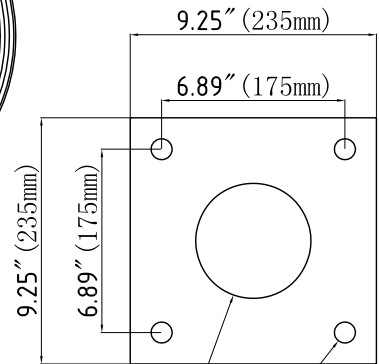

The size of the base cover is a closed size .

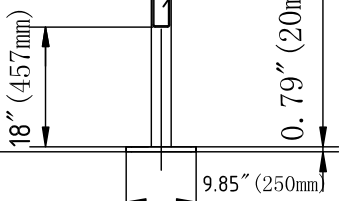

R20FT4-11G-D